

OVERALL DIMENSIONS

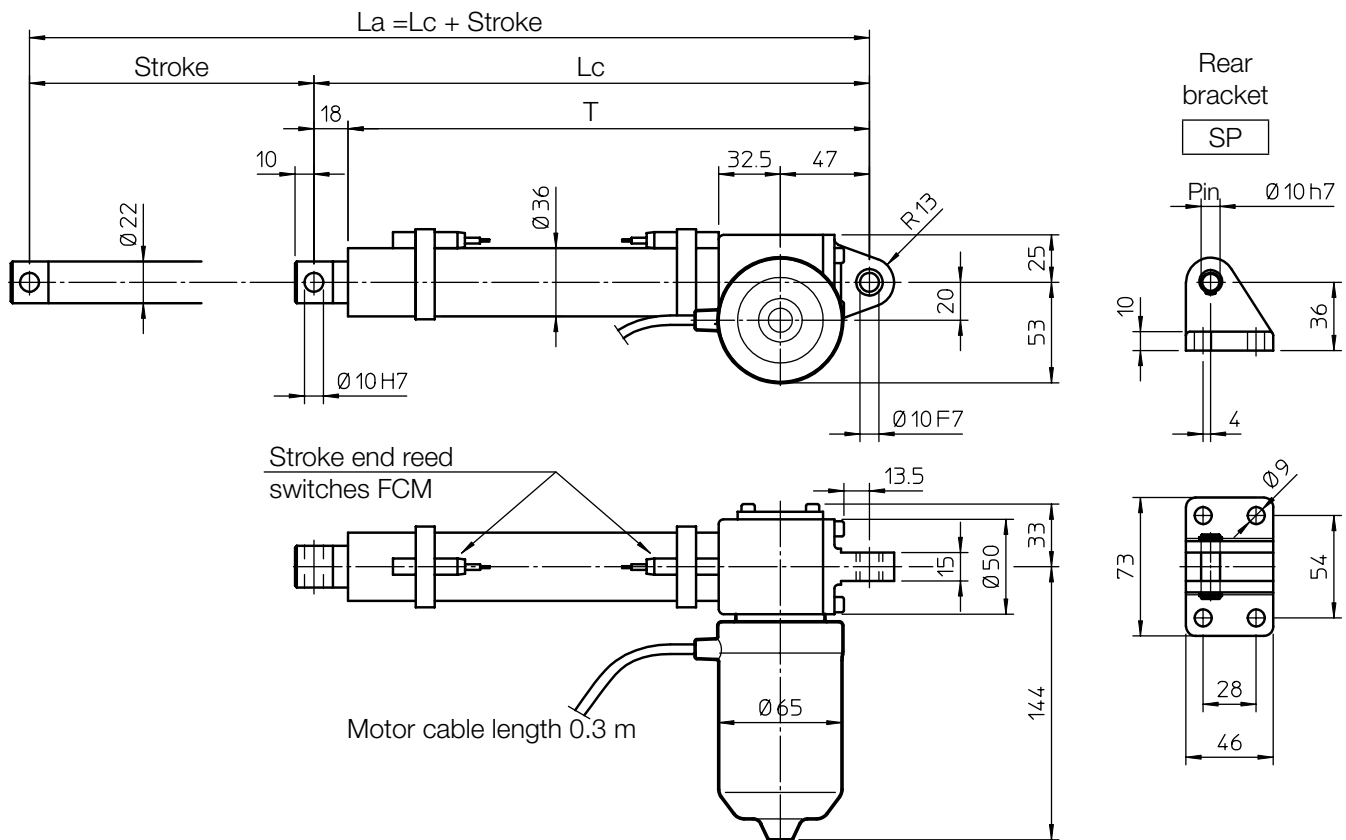

STROKE CODE	STROKE [mm]	LENGTH		T [mm]	MASS [kg]
		Lc [mm]	La [mm]		
C100	100	243	343	225	2.00
C150	150	293	443	275	2.25
C200	200	343	543	325	2.50
C300	300	443	743	425	2.75

Length	Stroke \leq 300 mm	Stroke $>$ 300 mm
Lc [mm]	143 + Stroke	158 + Stroke
T [mm]	125 + Stroke	125 + Stroke

PERFORMANCES AND FEATURES

- Pull-Push load up to 2 500 N
- Linear speed up to 32 mm/s
- Standard stroke lengths: 100, 150, 200, 300 mm (for different / longer stroke lengths please contact us)
- Aluminium alloy housing and rear attachment, with bronze bush
- Anodized aluminium outer tube
- Anodized aluminium push rod – tolerance h8
- Stainless steel AISI 303 front attachment
- 12, 24 or 36 V DC motor with electromagnetic noise suppressor (motor features details on page 69)
- Duty cycle with max load: 15% over 10 min at (-10 ... +40) °C
- Standard motor mounting position as per sketch (right-hand, code RH)

- Standard protection IP65
 - Test IP6X according to EN 60529 §12 §13.4-13.6
 - Test IPX5 according to EN 60529 §14.2.5 (tests made with not running actuator)
- Long-life lubrication, maintenance free

ACCESSORIES

- Stainless steel push rod (code SS)
- Rear bracket (code SP)
- Two adjustable stroke end reed switches (code FCM)
- Extra switches for intermediate positions

OPTIONS

- Motor mounting position on opposite side (left-hand, code LH)
- Fixing attachment turned at 90° (code RPT 90)

PERFORMANCES with 24 V DC motor

(Performances with 12 V DC motor: same load, linear speed 10 % less, electrical consumption 2 times more)

1-start acme screw Tr 13.5x3

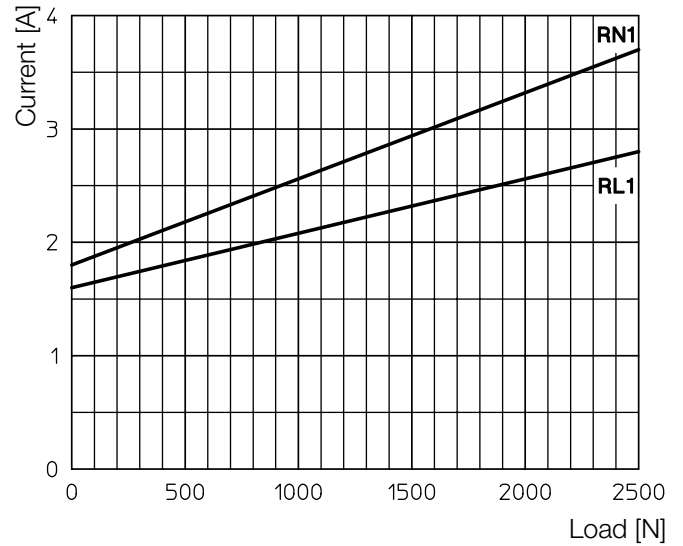
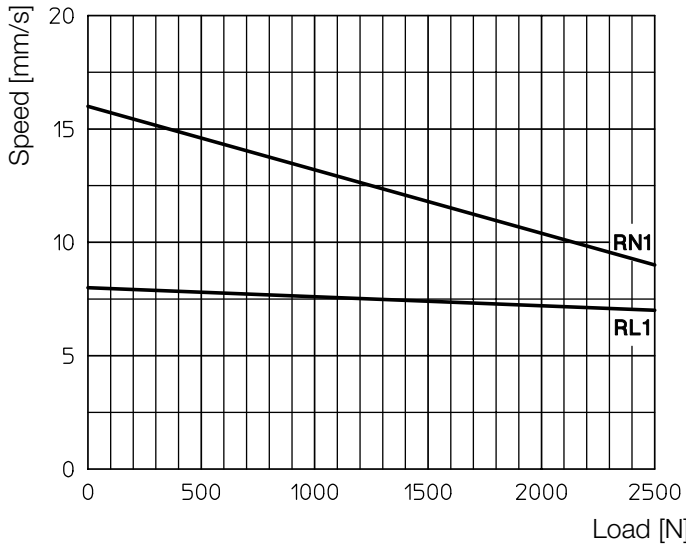

2-starts acme screw Tr 14x8 (P4)

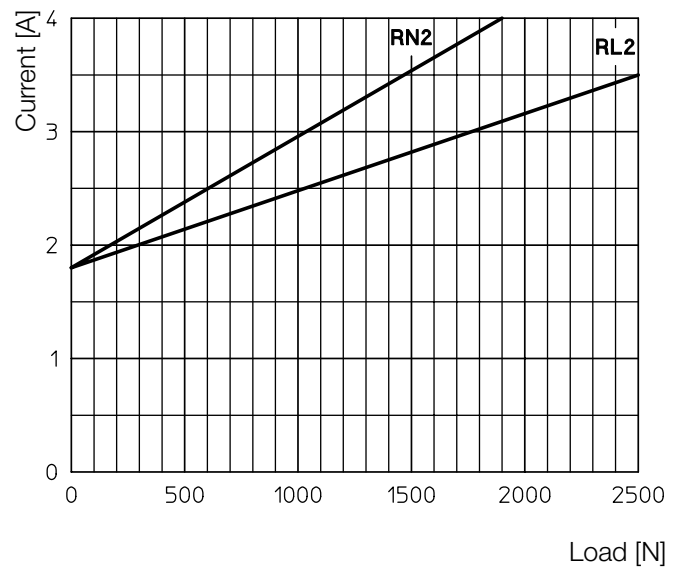
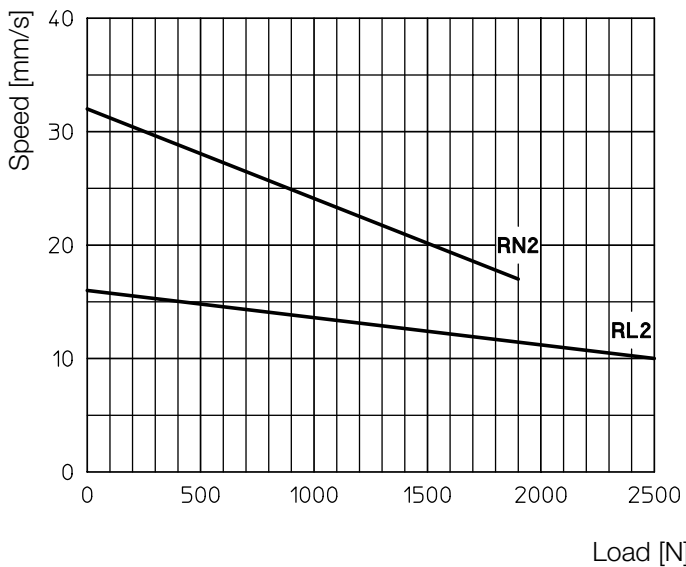

Self-locking conditions

Information about statically self-locking conditions with pull or push load on page 68.

ORDERING CODE EXAMPLE

ATL 05	RL1	C200	CC 24 V	FCM				
Actuator	Selected ratio	Required stroke	Motor	Stroke end switches	Accessories			Options

12. GENERAL FEATURES

12.3 DC MOTORS

Motors with interchangeable brushes (actuators ATL 10, UAL 0, BSA 10, BSA 11, UBA 0, CLB 25, CLB 27)

Permanent magnet DC motors, without fan, available with or without brake.

Long-life brushes, easy to replace.

Bipolar power supply cable 2 x 1 mm², 1.5 m length. Motor weight: 1.3 kg.

Output power	70 W		Rated speed	3000 rpm	
Rated current	3.7 A (24 V)	8.4 A (12 V)	Rated torque	0.22 Nm	
Peak current	18 A (24 V)	30 A (12 V)	Peak torque	1.1 Nm	
Resistance	0.85 Ohm (24 V)	0.23 Ohm (12 V)	Inductance	1.34 mH (24 V)	0.36 mH (12 V)
Protection class	IP 54		Insulation class	F	

MOTOR BRAKE: Normally closed holding brake activated by DC electromagnet available on request.

Brake separately wired with bipolar cable 2 x 1 mm², 1 m length.

Motor with brake total weight: 1.8 kg.

Power supply: 0.4 A a 24 V; 0.85 A a 12 V	Braking torque: 0.5 Nm
---	------------------------

WARNING! The motor brake is normally closed; to open it, a constant rated voltage power supply is required. With lower voltage, the brake does not open.

Motors with non-interchangeable brushes (linear actuators LMR, ATL, CLA, LMP, LMI Series)

Permanent magnet DC motors, without fan.

The brake is not available; the brushes are not interchangeable.

Standard motors winding has insulation class B.

These motors have open enclosures: the actuator is fitted with proper motor outer protections which allow to reach motor Protection Class IP 65.

The performance diagrams concerning actuators with DC motor stated in this catalogue, show the input power variation depending on the load variation.

This allows to select power supply / drivers properly.

Motor wires connection – Actuator push rod travelling direction

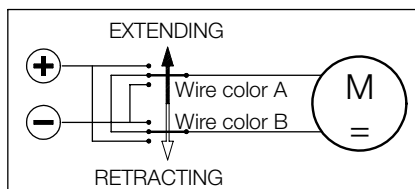

Actuator with DC motor, RIGHT-HAND mounting	LMR 01	LMR 03	ATL 02	ATL 05	ATL 08	ATL 12	CLA 20	CLA 25
Wire color A	red	red	brown	brown	brown	red	brown	brown
Wire color B	black	black	blue	blue	blue	blue	blue	blue

Actuator with DC motor, LEFT-HAND mounting	LMR 01	LMR 03	ATL 02	ATL 05	ATL 08	ATL 12	CLA 20	CLA 25
Wire color A	red	red	blue	blue	blue	blue	blue	blue
Wire color B	black	brown	brown	brown	brown	red	brown	brown

GENERAL NOTE

In case the linear actuator is used in an application where the stroke end switches must be connected to PLC or PC, we suggest to make the connection with a galvanic separation circuit.

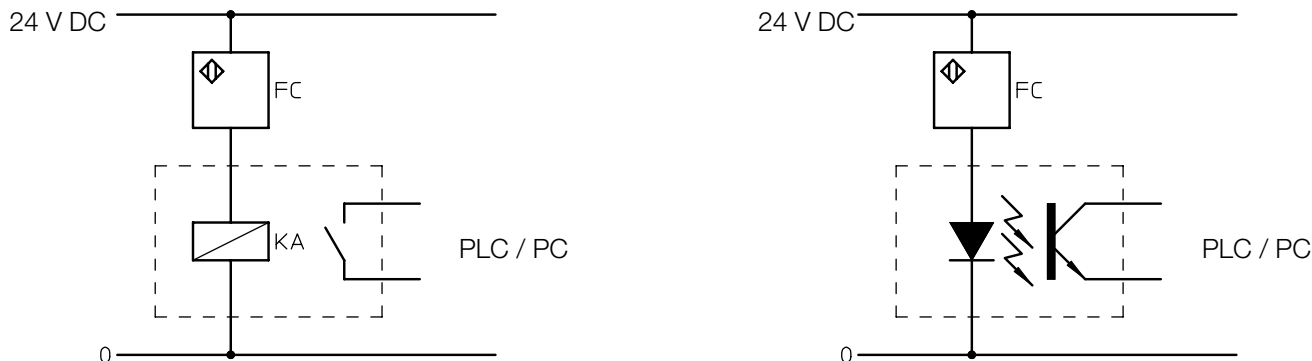

13.1 Magnetic stroke end switches (reed) FCM (linear actuators ATL, BSA, UAL, UBA Series, LMI 02 and LMP 03)

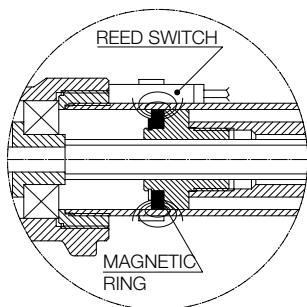

The magnetic field of the ring fixed on the nut activates the reed contact of the switch locked on the protective tube with a clamp.

The position of the switches along the tube is easily adjustable.

The switches used to determine any intermediate position (between L_c and L_a) will switch over in two different positions, depending on the push rod motion direction (extending or retracting).

WARNING! The magnetic reed-switches can work only if connected to a wiring control circuit in order to activate the electric relay. Do not connect them in series between the power supply and the electric motor!

REED CONTACT RATED VALUE

	DC	AC
Rated voltage	(3 ... 130) V	(3 ... 130) V
Max. commutable power	20 W	20 VA
Max. commutable current	300 mA (resistive load)	
Max. inductive load	3 W	

Standard: NC switch (normally closed contact) equipped with signalling LEDs and protective varistor against voltage peaks.

Standard cable length 2 m; wires 2 × 0.75 mm²

Different configurations available on request: NO (normally open); CS (exchanging contact).

For more information please contact our Technical Dpt.

13.2 Electric stroke end switches FCE (actuators ATL 10, ATL 12, BSA 10, BSA 12)

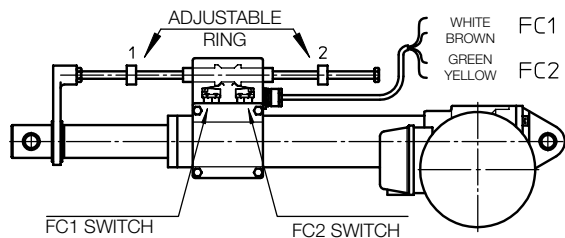

Two electric switches, installed inside a sealed plastic box, are activated by two adjustable rings through a shaft collar.

Standard switches are wired on the NC contact, cable length 1.5 m; wires 4 × 0.75 mm²

On request, they can be wired on the NO contact or on the switch-over contact CS (for available configurations please contact our Technical Dpt).

Min retracted length L_c is adjusted by ring 1. FC1 switch is connected with the WHITE and the BROWN cables.

Max extended length L_a is adjusted by ring 2. FC2 switch is connected with the YELLOW and the GREEN cables.

The position of the brass rings along the stainless steel supporting rod is easily adjustable.

CONTACT RATED VALUE

Voltage	Max current	
	Resistive load	Inductive load
250 Vac	5 A	3 A
30 Vdc	5 A	0.1 A
125 Vdc	1.4 A	-

WARNING! The electric reed switches can work only if connected to a wiring control circuit in order to activate the electric relay. Do not connect them in series between the power supply and the electric motor!